

Varenummer: 5012010
Beskrivelse: Glidebøsning FMT 10

Mål

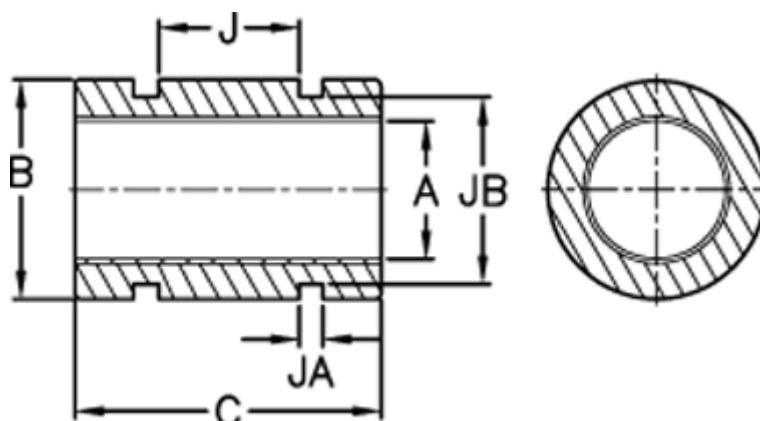

A max	= 10.035	J	= 12
A min	= 10.013	JA	= 2
B max	= 17	JB	= 14.4
B min	= 16.981999999999999	Koncentrisk mm	= 0.0254
Bøsning svægt kg	= 0.0085	Overfladeareal kcm	= 2.6
C max	= 26	Statisk belastning (kg)	= 546
C min	= 25.745999999999999		
For o-ring	= 14 x 1,6		